

NOTES:

Current Rating : 1.0AMP
 Contact Resistance : 20mΩ MAX
 Withstand Voltage : 500V AC/DC
 Insulation Resistance : 1000MΩ Min
 Operation Temperature : -40°C to +105°C

Contact Material : Brass Or Phosphor Bronze
 Contact plating : Au Or Sn over Ni
 Insulator Material : PBT +30%G.F UL94V-0

Ordering Inforination

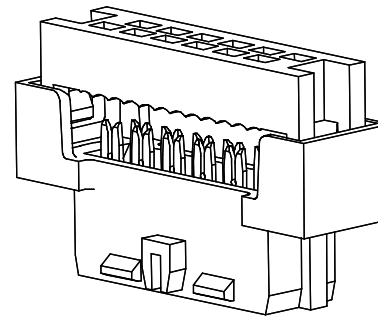
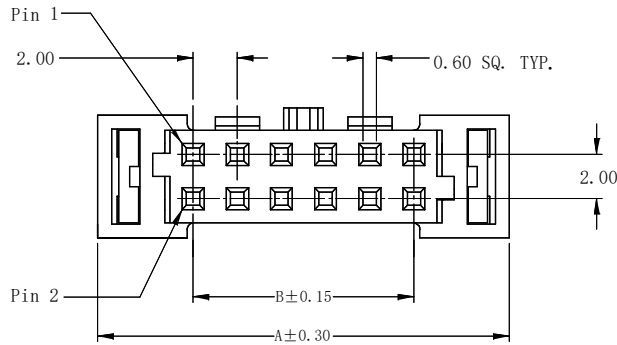

PY3203- XX	B	01	B	02
Series NO.	No. of Pos	Color Insulator	Bump A=A Type B=B Type C=C Type D=D Type	Piece 02=Two piece 03=Three piece
06P	26P	08P	30P	
10P	34P	12P	40P	
14P	44P	16P	50P	
18P		20P		
22P		24P		
			Contact Plating 01=Gold Flash/Ni 02=Sn 03=3u"Gold/Ni 05=5u"Gold/Ni 15=15u"Gold/Ni 30=30u"Gold/Ni	

A=2.0*NO of Positions/2+6.65
 B=2.0*NO of Positions/2-2.00
 C=2.0*NO of Positions/2+1.45

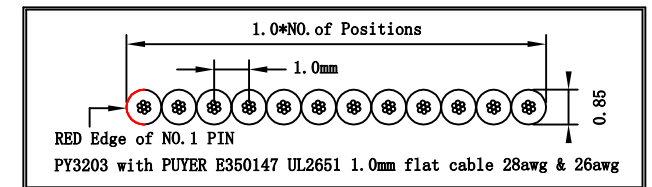
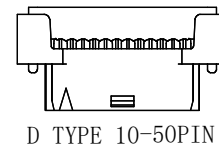
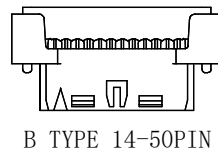
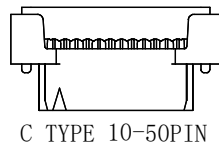
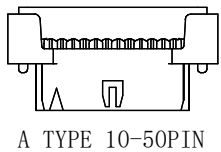

				OPERATION	DRAW	DATE	SCALE	FIT	PART NO.	PUYER 普亚电线有限公司 PUYER CABLE CO., LTD HTTP:www.puyercable.com
				X.	±0.20	2016/06/27	UNIT	mm	PY3203-XXBS0A01	
				X. X	±0.15	DATE	SIZE	A4	TITLE:	普亚电线 TEL:0769-85258775 FAX:0769-85251396 MOB:13711962670 QQ :405131416
AO	2016/06/27	NEW		X. XX	±0.10	DATE	SHEET	1/1	2.0 IDC SOCKET(molex type)	
REV	DATE	MODIFICATON DESCRIPTION	CHANGE	ANGLES	±2°	APPROVE			Customer NO.	
				DIM	TOL					